

**Make: BMW**

**Model: 4 Coupe**

**Part Number: ADB06110**

**Vehicle Manufacturing/Engine:**

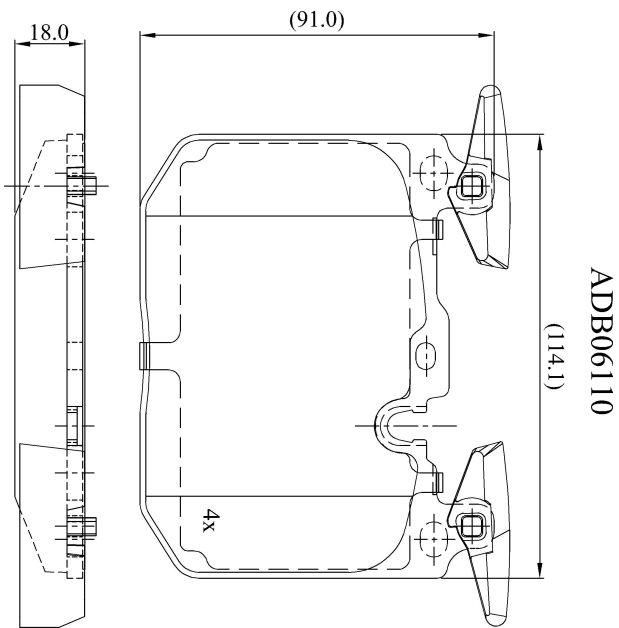

## Specifications

<b>Fitting Position</b>	:	Front
<b>Model Date</b>	:	2016-
<b>Or. Caliper</b>	:	
<b>WVA</b>	:	25028
<b>FMSI</b>	:	
<b>Length</b>	:	114.5
<b>Width</b>	:	91.4
<b>Thickness</b>	:	18.3