

Make: CITRON

Model: Dispatch/Jumpy

Part Number: ADB11001

Vehicle Manufacturing/Engine:

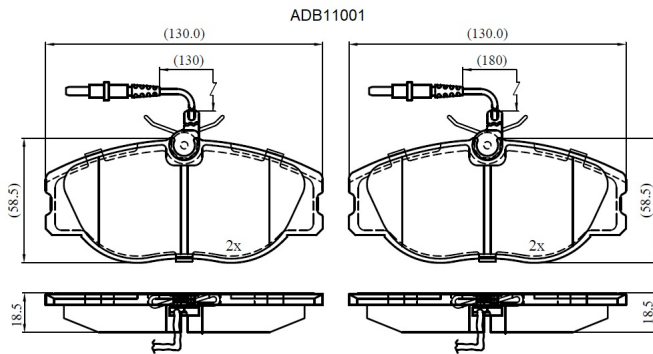

Specifications

| | | |
|-------------------------|---|---------|
| Fitting Position | : | Front |
| Model Date | : | 09/99-> |
| Or. Caliper | : | Lucas |
| WVA | : | 21801 |
| FMSI | : | |
| Length | : | 130 |

| | | |
|------------------|---|------|
| Width | : | 58.5 |
| Thickness | : | 18.5 |