

Make: DAIHATSU

Model: Boon

Part Number: ADB3793

Vehicle Manufacturing/Engine:

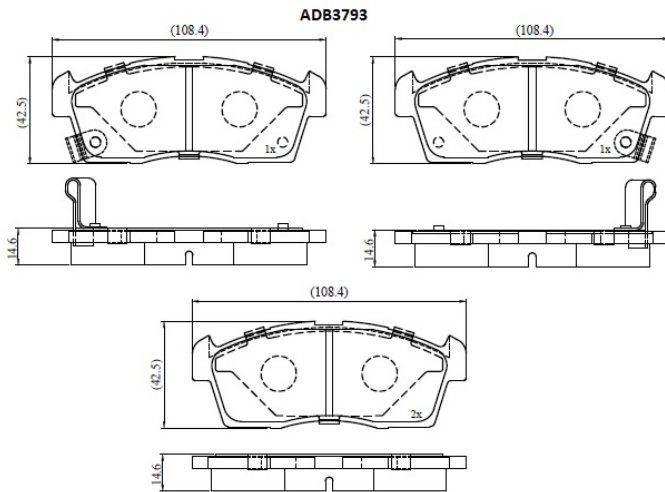

Specifications

Fitting Position	:	Front
Model Date	:	03/08->
Or. Caliper	:	Sumitomo

WVA	:	2,35,07,23,508
FMSI	:	
Length	:	109
Width	:	45
Thickness	:	14.8