

Make: FERRARI

Model: 308

Part Number: ADB0128

Vehicle Manufacturing/Engine:

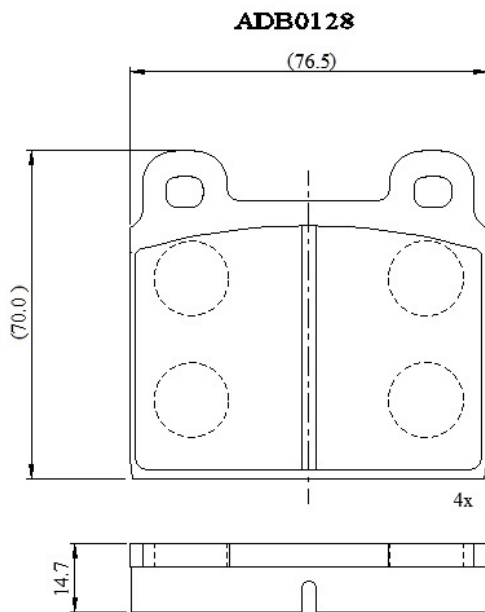

Specifications

Fitting Position	:	Front
Model Date	:	01/78-01/89
Or. Caliper	:	Ate
WVA	:	20011
FMSI	:	
Length	:	76.5
Width	:	70
Thickness	:	14.7