

Make: FORD

Model: KA+ III

Part Number: ADB03281

Vehicle Manufacturing/Engine:

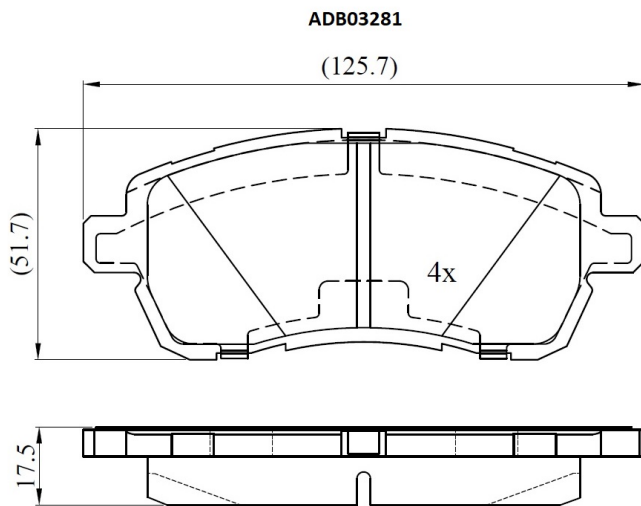

Specifications

Fitting Position	:	Front
Model Date	:	2018-
Or. Caliper	:	

WVA	:	22191
FMSI	:	
Length	:	125.7
Width	:	51.7
Thickness	:	17.5