

Make: HONDA

Model: CR-V

Part Number: ADB31736

Vehicle Manufacturing/Engine:

ADB31736

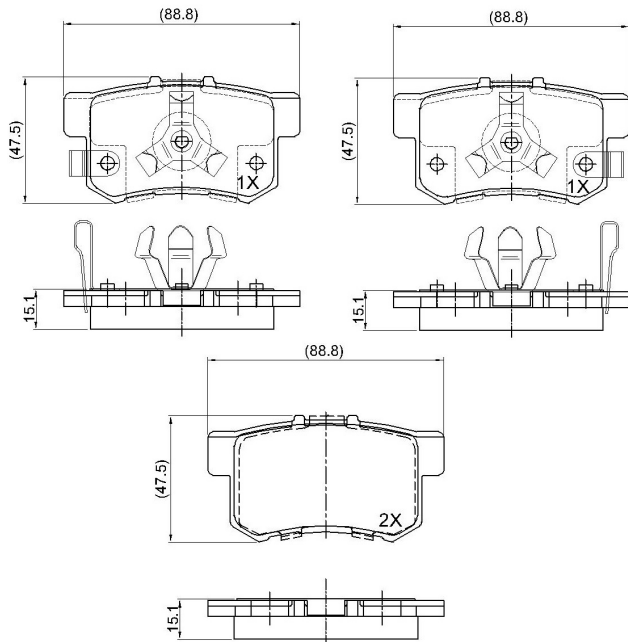

Specifications

Fitting Position	:	Rear
Model Date	:	02/05-->
Or. Caliper	:	Akebono
WVA	:	24,23,12,42,32,24,233
FMSI	:	
Length	:	88.8
Width	:	47.5
Thickness	:	15.1