

**Make: HYUNDAI**

**Model: Accent**

**Part Number: ADB31672**

**Vehicle Manufacturing/Engine:**

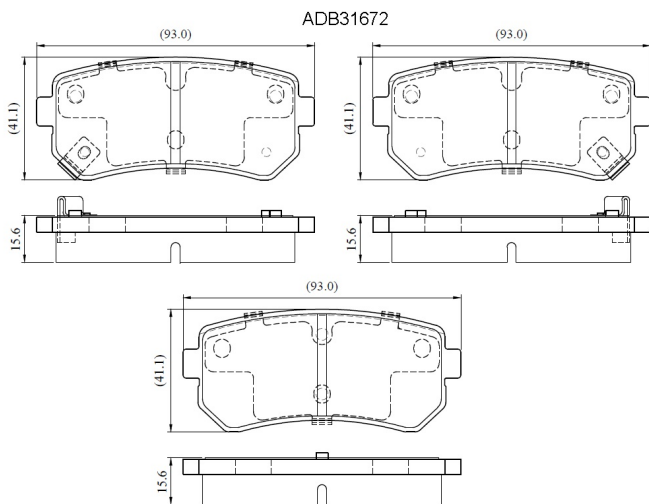

### Specifications

<b>Fitting Position</b>	:	Rear
<b>Model Date</b>	:	02/08-->
<b>Or. Caliper</b>	:	Mando

<b>WVA</b>	:	24320
<b>FMSI</b>	:	
<b>Length</b>	:	93
<b>Width</b>	:	41.1
<b>Thickness</b>	:	15.6/16.2