

Make: HYUNDAI

Model: Verna IV

Part Number: ADB32040

Vehicle Manufacturing/Engine:

ADB32040

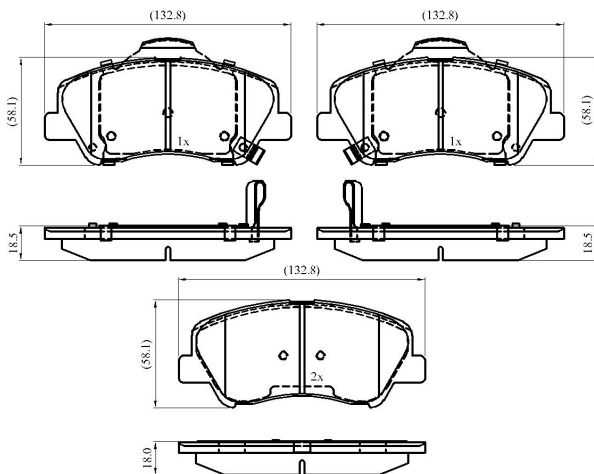

Specifications

Fitting Position	:	Front
Model Date	:	10/11-
Or. Caliper	:	Mando

WVA	:	25348, 25349, 25350
FMSI	:	
Length	:	132.8
Width	:	58.1
Thickness	:	18