

**Make: HYUNDAI**

**Model: XG 30**

**Part Number: ADB3879**

**Vehicle Manufacturing/Engine:**

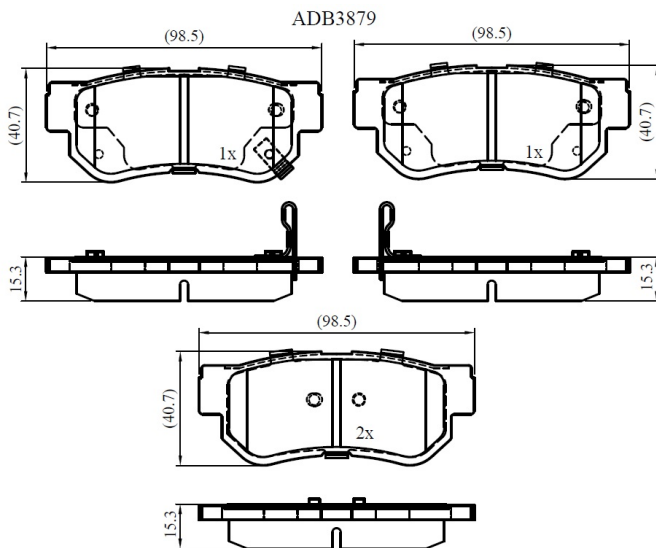

### Specifications

<b>Fitting Position</b>	:	Rear
<b>Model Date</b>	:	05/00->

<b>Or. Caliper</b>	:	Mando
<b>WVA</b>	:	
<b>FMSI</b>	:	
<b>Length</b>	:	98.5
<b>Width</b>	:	40.6
<b>Thickness</b>	:	15.5