

Make: LANCIA

Model: Kappa

Part Number: ADB0895

Vehicle Manufacturing/Engine:

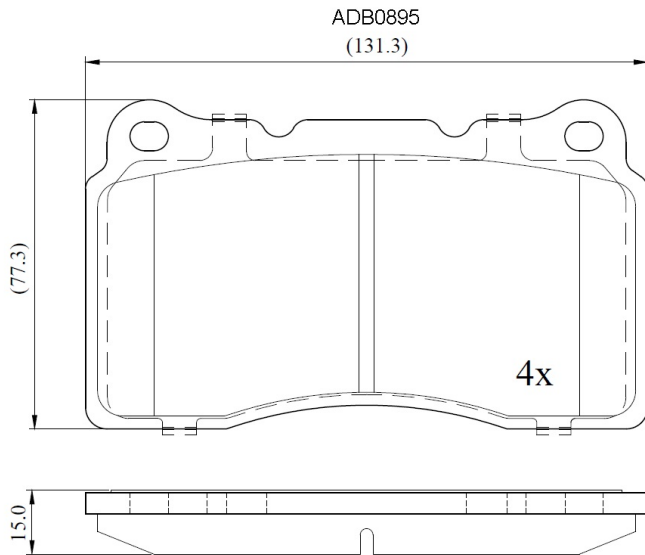

Specifications

Fitting Position	:	Front
Model Date	:	10/98-05/01

Or. Caliper	:	Brembo
WVA	:	23092
FMSI	:	
Length	:	131.3
Width	:	77.3
Thickness	:	15