

**Make: LANDROVER**

**Model: Range Rover Sport**

**Part Number: ADB01726**

**Vehicle Manufacturing/Engine:**

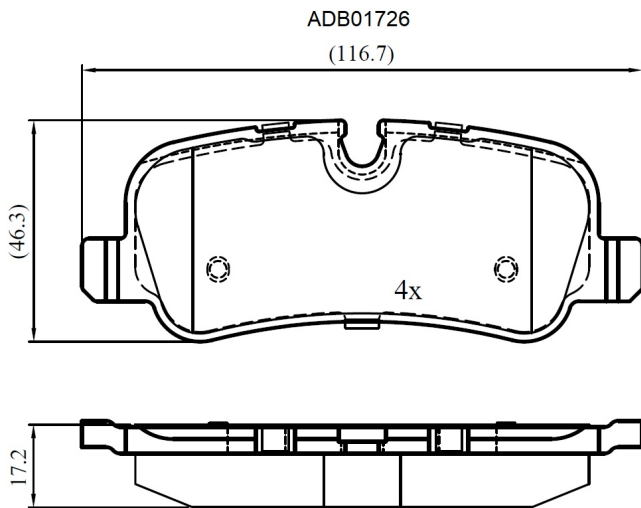

### Specifications

<b>Fitting Position</b>	:	Rear
<b>Model Date</b>	:	09/09->
<b>Or. Caliper</b>	:	

<b>WVA</b>	:	24192
<b>FMSI</b>	:	
<b>Length</b>	:	116.7
<b>Width</b>	:	46.3
<b>Thickness</b>	:	17.2