

**Make: MAZDA**

**Model: 3**

**Part Number: ADB33285**

**Vehicle Manufacturing/Engine:**

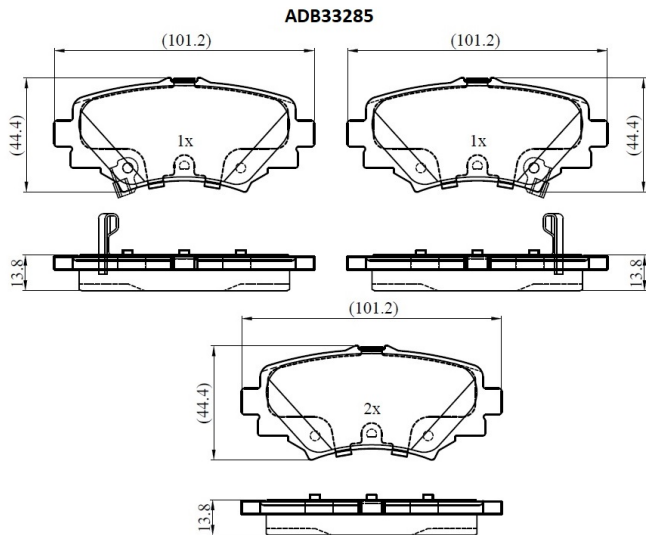

### Specifications

<b>Fitting Position</b>	:	Rear
<b>Model Date</b>	:	2013-2019

<b>Or. Caliper</b>	:	
<b>WVA</b>	:	25878
<b>FMSI</b>	:	
<b>Length</b>	:	101.2
<b>Width</b>	:	44.4
<b>Thickness</b>	:	13.8