

Make: MAZDA

Model: 6

Part Number: ADB01655

Vehicle Manufacturing/Engine:

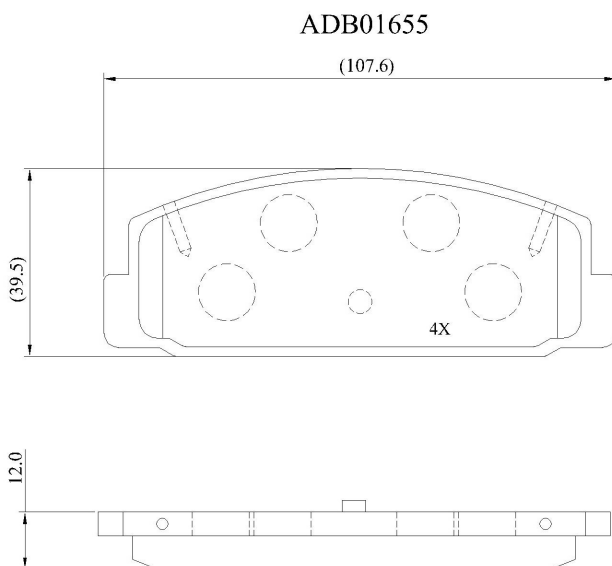

Specifications

Fitting Position	:	Rear
Model Date	:	03/05->

Or. Caliper	:	
WVA	:	
FMSI	:	
Length	:	107.6
Width	:	39.5
Thickness	:	12