

**Make: MERCEDES-BENZ**

**Model: S-CLASS Convertible**

**Part Number: ADB03165**

**Vehicle Manufacturing/Engine:**

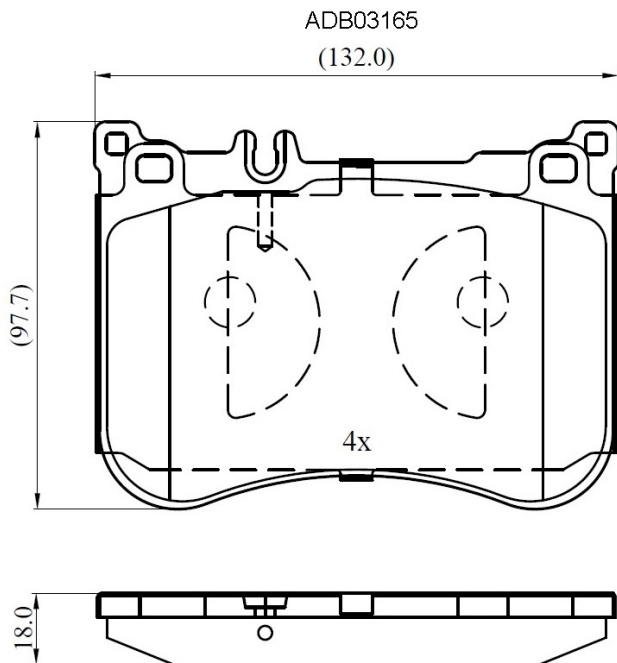

## Specifications

<b>Fitting Position</b>	:	Front
<b>Model Date</b>	:	2017-2020
<b>Or. Caliper</b>	:	
<b>WVA</b>	:	25179
<b>FMSI</b>	:	
<b>Length</b>	:	132
<b>Width</b>	:	97.5
<b>Thickness</b>	:	17.8