

**Make: MITSUBISHI**

**Model: Lancer VII**

**Part Number: ADB32859**

**Vehicle Manufacturing/Engine:**

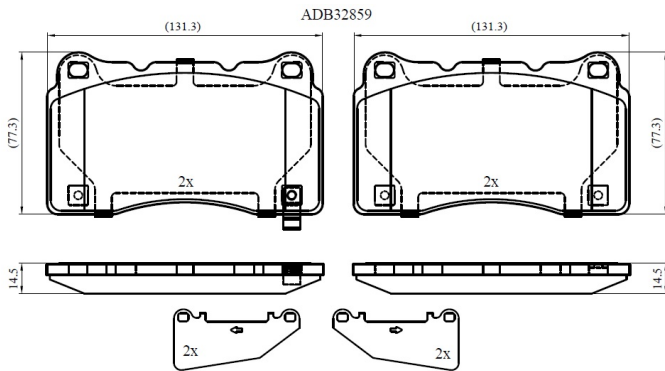

### Specifications

<b>Fitting Position</b>	:	Front
<b>Model Date</b>	:	2004-2006
<b>Or. Caliper</b>	:	
<b>WVA</b>	:	25,85,02,58,51,25,852
<b>FMSI</b>	:	

<b>Length</b>	:	131.8
<b>Width</b>	:	77
<b>Thickness</b>	:	14.8