

Make: NISSAN

Model: Stanza

Part Number: ADB32750

Vehicle Manufacturing/Engine:

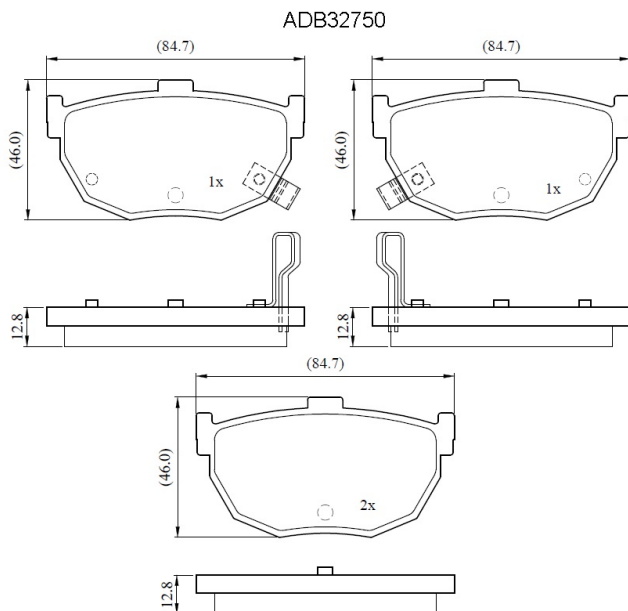

Specifications

Fitting Position	:	Rear
Model Date	:	90-92

Or. Caliper	:	
WVA	:	
FMSI	:	D323
Length	:	84.7
Width	:	46
Thickness	:	12.8