

Make: PEUGEOT

Model: 308 II

Part Number: ADB02335

Vehicle Manufacturing/Engine:

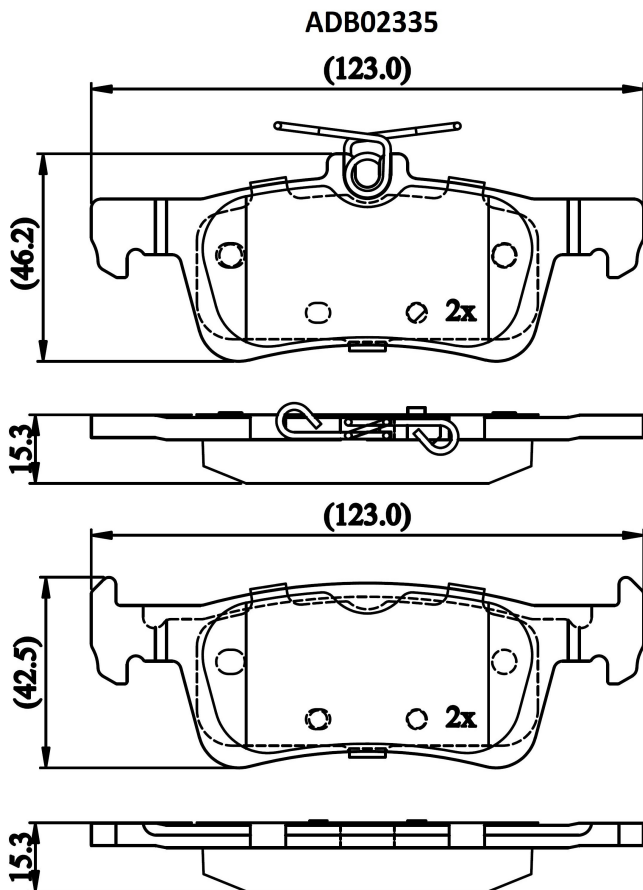

Specifications

Fitting Position

:

Rear

Model Date	:	3/2014 >
Or. Caliper	:	
WVA	:	2,58,41,25,842
FMSI	:	
Length	:	123
Width	:	46.20/42.50
Thickness	:	15.3