

**Make: TOYOTA**

**Model: RX 350**

**Part Number: ADB01750**

**Vehicle Manufacturing/Engine:**

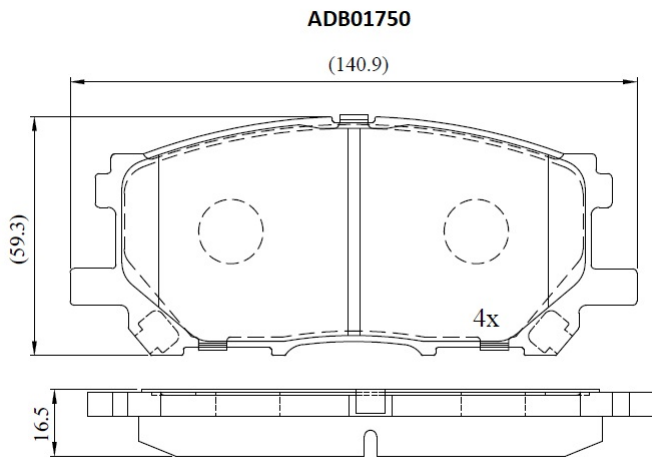

### Specifications

<b>Fitting Position</b>	:	Front
<b>Model Date</b>	:	02/06->
<b>Or. Caliper</b>	:	Sumitomo

<b>WVA</b>	:	2,37,34,23,989
<b>FMSI</b>	:	
<b>Length</b>	:	140.9
<b>Width</b>	:	59.3
<b>Thickness</b>	:	16.5